

RCBS[®]

ROCK CHUCKER™ SUPREME
AUTO PRIME

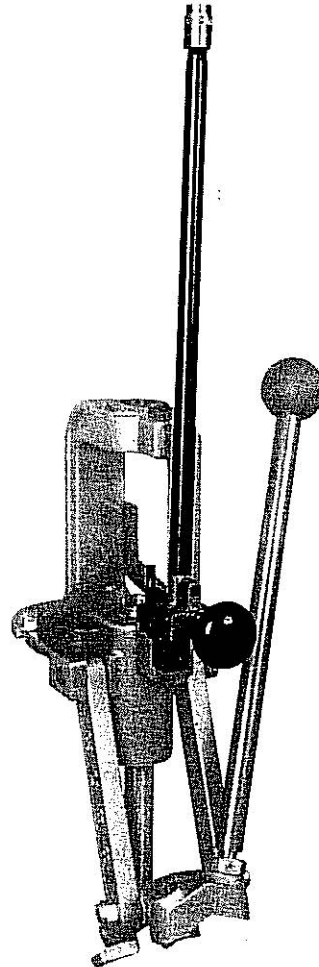

PRODUCT INSTRUCTIONS

SAFETY

Reloading is an enjoyable and rewarding hobby that is easily conducted with safety. But carelessness or negligence can make reloading hazardous. This product has been designed from the beginning with the user's safety in mind.

As with any reloading operation, some safety rules must be followed. By observing these few rules, the chance of hazardous occurrence causing damage or injury becomes extremely remote.

GENERAL

- Use the equipment as the manufacturer recommends. Study the instructions carefully and become thoroughly familiar with the operation of the product. Don't take short cuts.
- Observe "good housekeeping" in the work area. Keep tools and components neat, clean and orderly. Promptly clean up any powder spills.
- Always wear adequate eye protection.
- If any unusual resistance is encountered when moving the operating handle, STOP IMMEDIATELY and investigate the cause. To proceed against unusual resistance may damage equipment and/or cause serious injury!

LOADING DATA

- Use only laboratory tested data. We highly recommend the use of the SPEER Reloading Manual.
- OBSERVE ALL WARNINGS ABOUT THE USE OF MAXIMUM LISTED LOADS.

PRIMER HANDLING

- WARNING: Primers are designed to explode and will do so when subjected to heat or percussion.
- Do not decap live primers!
- Never attempt to seat or reseat a primer in a loaded cartridge.
- Store primers and powder beyond the reach of children and away from heat, dampness, open flames and electrical equipment.
- DO NOT use any primer unless its identity is positively known. Discard all mixed primers and those of uncertain or unknown identity.
- After a reloading session ends, return the remaining primers back into its original factory container. This will preserve the identity and shelf life of the primers.
- DO NOT SMOKE while handling powder or primers..

RECORD KEEPING

- Keep complete records of reloads. Apply a descriptive label to each box showing the date produced, and the primer, powder and bullet used. Labels for this purpose are packed with SPEER bullets.

Since RCBS has no control over the choice of components, the manner in which they are assembled, the use of this product, or the firearms in which the resulting ammunition may be used, no responsibility, either expressed or implied, is assumed for the use of ammunition reloaded with this tool.

RCBS ROCK CHUCKER SUPREME AUTO PRIME

The RCBS Rock Chucker Supreme Auto Prime gives you a ready supply of primers and reduces the potential for contamination by eliminating the touching of primers by hand.

UNPACKING

Unpack the box carefully and look for the following items listed below. Refer to the parts list for identification.

- Primer Tube Large
- Primer Tube Small
- Primer Feed Tube Assembly Large
- Primer Feed Tube Assembly Small
- Safety Tube with Cap
- Bag #1:
 - Primer Dispenser Upper Body
 - Plunger
 - Spring
 - SHSS
- Bag #2:
 - Primer Dispenser Lower Body
 - SHCS-short(2)
 - SHCS-long
 - SHSS(2)
- Bag #3:
 - Primer Transfer Bar assembly
 - Primer Plug Large
 - Primer Plug Small
 - Primer Plug Sleeve Large
 - Primer Plug Sleeve Small
 - Primer Plug Spring
 - Primer Arm Return Spring
 - Cotter Pin(2)

ASSEMBLY

Open parts bag #1 and remove parts. Install the plunger as shown in Photo 1. Insert the spring tapered end first. Install SHSS. Do not over tighten. the SHSS should be threaded to flush with the housing.

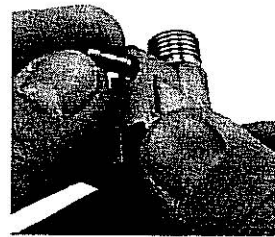

Photo 1

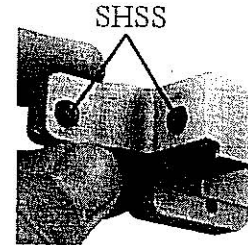

Photo 2

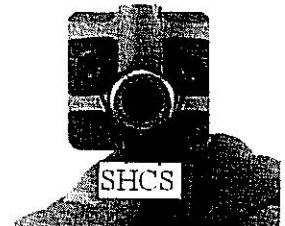

Photo 3

Open parts bag #2 and remove parts. Start the two SHSS as shown in Photo 2. These will be adjusted later to secure the housing to the press frame. Install the two short SHCS through the Upper Body assembly, into the Lower Body and lightly secure, see Photo 3. These SHCS will be tightened later after aligning the Dispenser with the press Ram. Place the assembly onto the press frame and secure with the SHCS as shown in Photo 4.

Open parts bag #3 and remove parts. Slide the large spring over the shaft of the Primer Transfer bar. Insert the primer arm through the Primer Dispenser assembly attached to the press. See Photo 5. Choose your desired size primer seat plug parts. Drop the Primer Plug into the Primer Sleeve, slide the spring over the Primer Plug shaft. Thread the assembly into the end of the Primer Arm. See Photo 6.

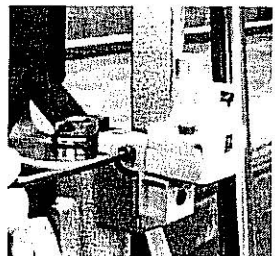

Photo 4

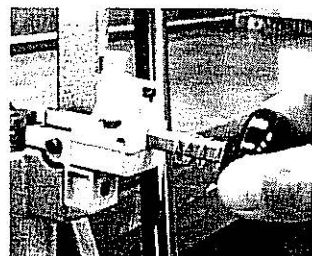

Photo 5



Photo 6

Install your desired shell holder into the press Ram. Lower the press handle enough to allow you to push the Primer Transfer bar into the slot in the front of the press Ram. Hold the Transfer Bar in and raise the handle until the shell holder rests on the Transfer Bar arm. Tighten the lower SHSS in the lower body (see Photo 7). Lower the handle to release the Transfer Bar and tighten the upper SHSS. Both should be snug against the press frame. **CAUTION:** Do not over tighten!

Push the Transfer Bar back in and raise the handle until the shell holder rests on it again. Tighten the two short SHCS in Photo 8. **CAUTION:** Do not over tighten. Lower the handle to release the Transfer Bar.

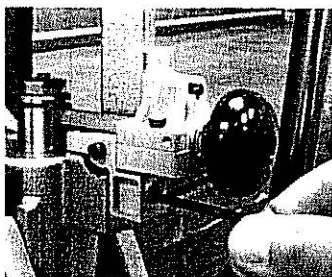

Photo 7

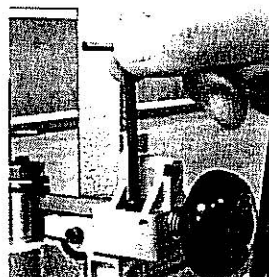

Photo 8

Insert the appropriate Primer Tube into the assembly. See Photo 9. The Primer Tube is the one **WITHOUT** the small tapered plastic piece attached. Loosen the Cap on the black steel Safety Tube. Slide the Safety Tube over the Primer Tube and thread it into the housing. Once the Safety Tube is completely threaded onto the housing, secure the Primer Tube by tightening the Safety Tube Cap.

FILLING THE PRIMER TUBE

We recommend the RCBS Primer Tray-2 to be used in conjunction with the primer feed

tube. This plastic primer tray and cover have been designed to orient primers for fast, easy handling and primer pick-up.

Step 1. Scatter the primers onto the grooved surface of the primer tray. Then, gently shake the tray horizontally until all the primers are positioned anvil side up. Place the cover on the tray, while holding the tray and cover together. Turn the tray upside down. The primers will now be oriented anvil side down for easy pick-up with the appropriate size Priming Feed Tube assembly.

Step 2. Insert the Primer Feed Tube Cotter Pin into the cross hole before picking up any primers.

WARNING: It is the responsibility of the operator to insure that all primers are properly oriented. Attempting to seat a primer upside down in a case may cause the primer to detonate, causing serious personal injury or damage to the equipment. Primer residue is dangerous when exposed to heat, impact and/or static electricity. Therefore, it is important to keep the primer tubes clean. We recommend periodic cleaning with soap and warm water.

Step 3. Use the plastic tipped end of the tube opposite the cotter pin for primer pick-up. After filling, place the tube, cotter pin end down, onto the top of the safety tube cap. While holding the tube, remove the cotter pin, dropping the primers into the top of the safety tube cap. Be sure all primers are transferred into the Priming Tube. See photo 10.



Photo 9

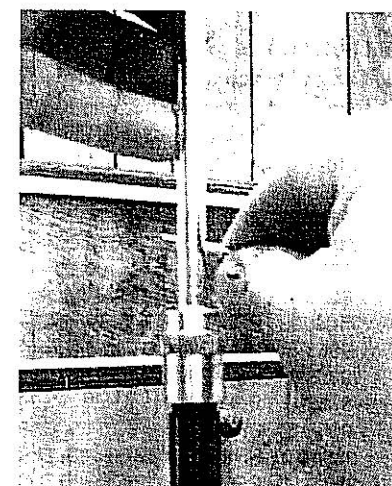

Photo 10

WARNING:

Care must be taken when loading the primer feed tube. Do not force primers because of the stacked condition of the primers. If one should ignite, all the primers in the tube will explode, causing an extreme hazard. No more than five pounds of force should be applied when picking up primers with the primer feed tube (this can be checked using a bathroom scale). If difficult primer pick-up should occur, investigate the cause and clear the condition or return the primer feed tube to RCBS for correction. Always wear eye protection when handling primers.

PRIMING ON YOUR ROCK CHUCKER SUPREME PRESS

Start by sizing and de-priming a case. Lower the ram until the slot in front is level with press frame. Next, with your free hand, pull out on the primer Transfer Bar until it picks up a primer. With the ram still in position, push the primer Transfer Bar into the slot in the press ram until it stops. While holding the Transfer Bar in, lower the ram until the primer is fully seated.

Now release the Transfer Bar as you lower the handle and raise the ram slightly. This will spring the transfer bar out of the slot in the ram.

PRIMER SIZE CHANGEOVER

Select the correct primer plug and sleeve (large or small). Drop the Primer Plug through the sleeve. Place the spring on the primer plug. Screw the Primer Plug into the transfer bar. Tighten the assembly with a small nail or a straightened paper clip through the hole in the Primer Plug. Do not over tighten. See photo 6.

Remove the safety tube cap. Remove the empty tube inside the safety tube. Install the correct tube, large or small, inside the safety tube. See photo 9. Install the safety tube cap onto the safety tube.

MAINTENANCE

Care should be taken not to apply oil where it could come in contact with primer pockets or primers. Oil will deactivate primers. It is a good practice to clean the press prior to lubrication to remove grit and other residue.

Item#	Qty	Part #	Description
1	1	7109596	AUTO PRIMER FEED SPRING
2	1	9358-1	PRIMER FEED, BASE
3	1	9358-2	PRIMER FEED, TOP
4	1	7188107	TRANSFER BAR COMPRESSION SPRING
5	1	9358-4	UPA SLEEVE LARGE
6	1	9358-5	UPA SLEEVE SMALL (NOT SHOWN)
7	1	7109508	PRIMER PLUG SPRING
8	1	9358-6	UPA PIN LARGE
9	1	9358-7	UPA PIN SMALL (NOT SHOWN)
10	1	9358-8	STOP PIN
11	1	9358-3	PRIMER TRANSFER BAR
12	1	9358-10	PRIMER TUBE SHIELD
13	1	9358-11	PRIMER TUBE SHIELD CAP
14	1	9358-12	PRIMER TUBE LARGE
15	1	9358-13	PRIMER TUBE SMALL (NOT SHOWN)
16	1	7102171	PRIMER TUBE LARGE BLANK
17	1	7102172	PRIMER TUBE SMALL BLANK (NOT SHOWN)
18	2	7109599	APF COTTER PIN
19	1	7109585	PRIMER TIP LARGE
20	1	7109586	PRIMER TIP SMALL (NOT SHOWN)
21	1	9358-9	PRIMER KNOB
22	2	9358-15	8-32 x 7/8L SHCS, STEEL, BLACK OXIDE
23	2	9358-16	8-32 x 5/8L SHCS, STEEL, BLACK OXIDE
24	1	7109591	1/4-28 x 3/16L SSS, CUP POINT, STEEL, BLACK OXIDE
25	2	9358-14	1/4-28 x 1/4L SSS, FLAT POINT, STEEL, BLACK OXIDE

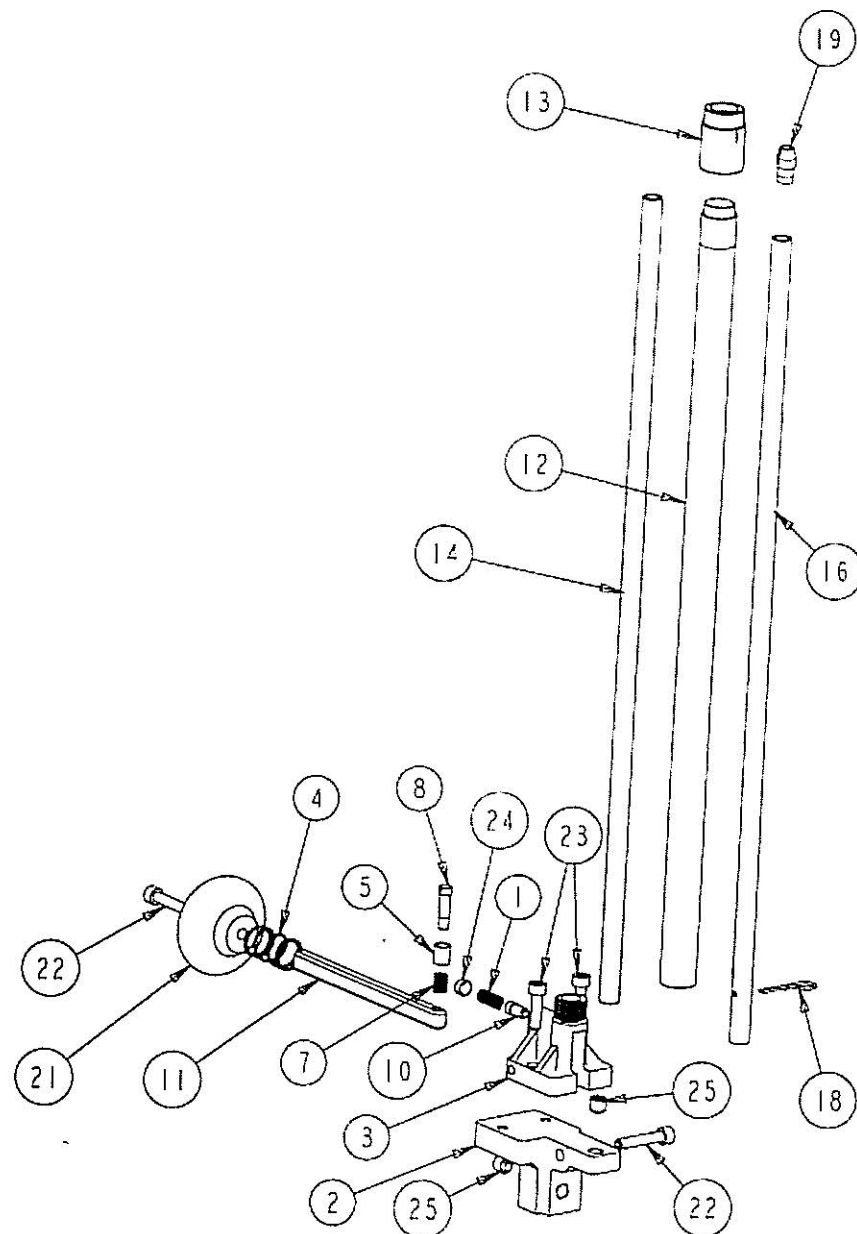



PRECISIONEERED RELOADING EQUIPMENT

We think that we make the very best reloading equipment in the world. If you agree, please tell your friends. If you disagree, tell us we want to do something about it!

Customer Service

1-800-533-5000 (US or Canada) or 530-533-5191

Hours: Monday - Thursday, 6:30am - 3:00pm Pacific Time
(hours may vary)

e-mail: rcbs.tech@atk.com or visit our website at www.rcbs.com

RCBS 605 Oro Dam Blvd. Oroville, CA 95965

CCI - SPEER - RCBS
OUTERS - RAMLINE - ORBEX - FEDERAL