

RCBS®

PRIMING TOOLS AND ACCESSORIES

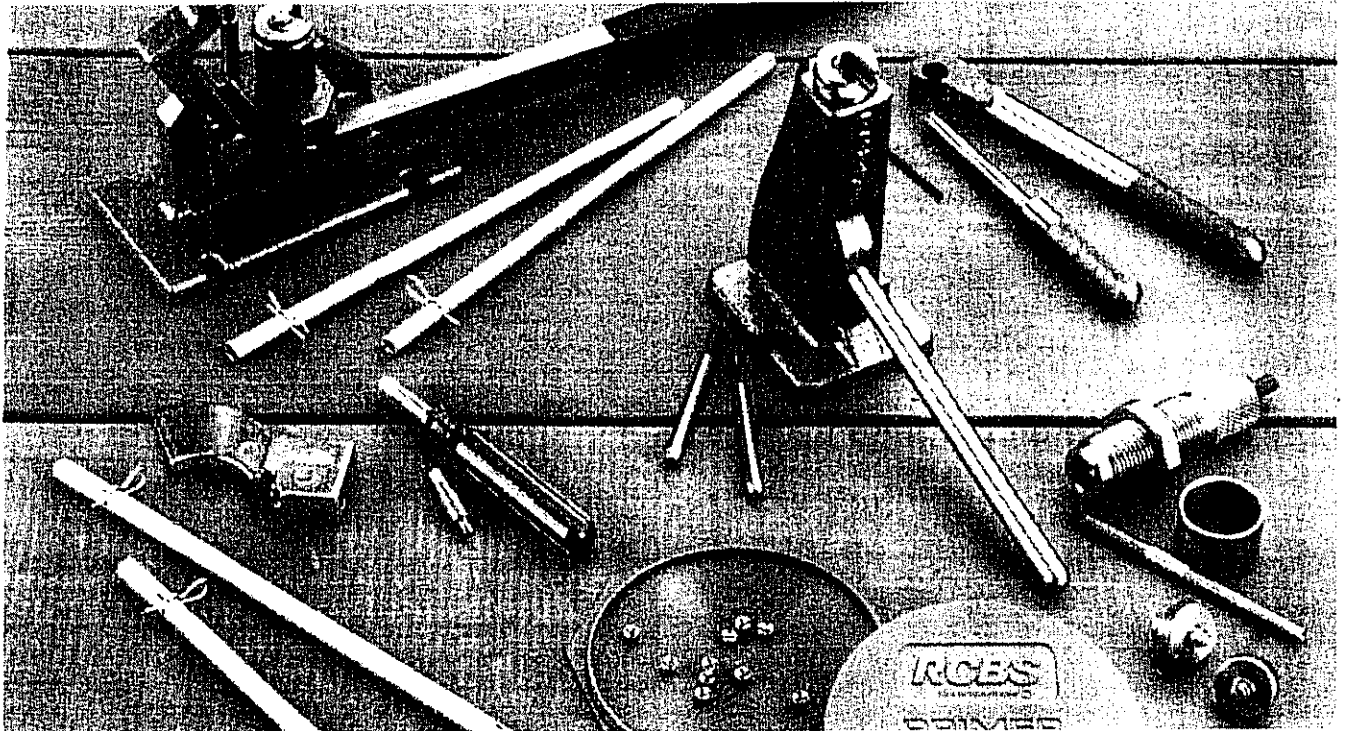

PRODUCT INSTRUCTIONS

SAFETY

Reloading is an enjoyable and rewarding hobby that is easily conducted with safety. But carelessness or negligence can make reloading hazardous. This product has been designed from the beginning with the user's safety in mind.

As with any reloading operation, some safety rules must be followed. By observing these few rules, the chance of hazardous occurrence causing damage or injury becomes extremely remote.

GENERAL

- Use the reloading equipment as the manufacturer recommends. Study the instructions carefully and become thoroughly familiar with the operation of the product. Don't take short cuts.
- Observe "good housekeeping" in the reloading area. Keep tools and components neat, clean and orderly. Promptly and completely clean up primer and powder spills.
- Reload only when you can give your undivided attention. Do not reload when fatigued or ill. Develop a reloading routine to avoid mistakes. Avoid haste – load at a leisurely pace.
- Always wear adequate eye protection. You assume unnecessary risk when reloading without wearing safety glasses.

LOADING DATA

- Use only laboratory tested reloading data. We highly recommend the use of the SPEER Reloading Manual.
- OBSERVE ALL WARNINGS ABOUT THE USE OF MAXIMUM LISTED LOADS.

PRIMERS AND POWDER

- **WARNING:** Primers are designed to explode and will do so when subjected to heat or percussion.
- Do not decap live primers.
- Never attempt to seat or reseat a primer in a loaded round.
- Store primers and powder beyond the reach of children and away from heat, dampness, open flames and electrical equipment.
- **DO NOT** use primers of unknown identity.
- Dispose of unknown primers in accordance with applicable regulations.
- Keep primers in original factory container until ready to use. Return unused primers to the same factory packaging for safety and to preserve their identity.
- **DO NOT** store primers in bulk. The blast of just a few hundred primers is sufficient to cause serious injury to anyone nearby.
- **DO NOT** force primers. Use care in handling primers.
- **DO NOT** use any powder unless its identity is positively known. Discard all mixed powders and those of uncertain or unknown identity.
- If you use a powder measure, replace the lids on both the powder hopper and the powder can after the powder hopper has been filled.
- Before charging cases, settle the powder in the powder hopper. Throw and check the weight of at least ten charges. This will assure you that the correct powder charge is being thrown.
- After a reloading session ends, pour the remaining powder back in its original factory container. This will preserve the identity and shelf life of the powder.
- **DO NOT** smoke while handling powder or primers.

RECORD KEEPING

- Keep complete records of reloads. Apply a descriptive label to each box showing the date produced, and the primer, powder and bullet used. Labels for this purpose are packed with SPEER bullets.

Since RCBS has no control over the choice of components, the manner in which they are assembled, the use of this product, or the guns in which the resulting ammunition may be used, no responsibility, either expressed or implied, is assumed for the use of ammunition reloaded with this product.

AUTOMATIC PRIMING TOOL

WARNING: Care must be taken when loading the Auto Primer Feed Tube. DO NOT force primers. Because of the stacked condition of the primers, if one should ignite, all the primers in the tube can explode causing serious personal injury. No more than five pounds pressure should be applied when picking up primers with the Auto Primer Feed Tube (this can be checked using a bathroom scale). If difficulties occur in primer pick-up, investigate the cause and clear the condition or return the Auto Primer Feed Tube to RCBS for correction.

TO INSTALL: Bolt Priming Tool to the reloading bench or table, using the slots provided in the Main Body Casting. Mount tool toward the front edge of the bench so that the handle will operate through its full stroke. Insert a Shell Holder into the Main Ram and rotate it to a convenient working angle. Then, using the proper Primer Rod Assembly (for large or small primers), insert the rod into the Shell Holder and Main Ram until it contacts the handle.

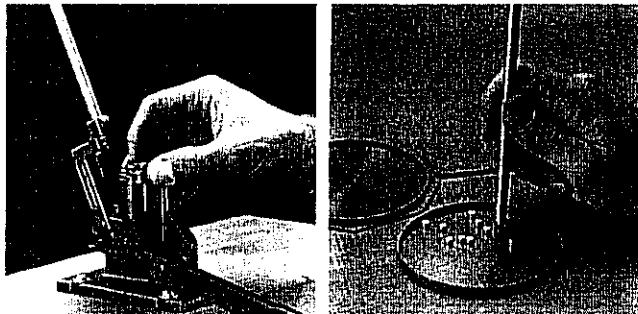

Snap the shell holder into the ram. Fill a primer tube.

NOTE: The Primer Rod Assemblies have been designed to allow for replacement of the individual components. To assemble the Primer Rod Assemblies: Select the correct primer plug and sleeve (large or small). Drop the Primer Plug through the Sleeve. Place the Spring on top of the Primer Rod. Screw the Primer Plug into the top of the Primer Rod. Tighten the assembly with a small nail or straightened paper clip through the hole in the Primer Plug. Do not over-tighten. Before changing Shell Holders, you must first lift out the Primer Rod Assembly.

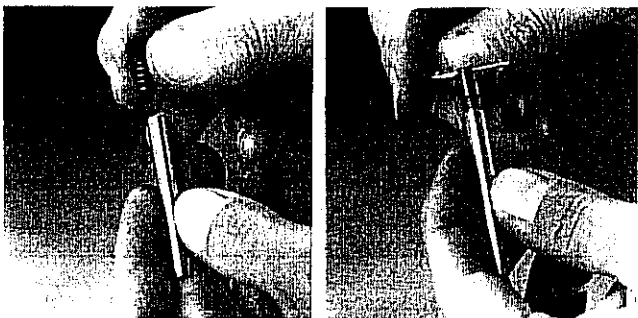

The primer plug, sleeve and spring Tighten the primer rod assembly with a straightened paper clip.

TO FILL PRIMER TUBE: Select the proper Automatic Primer Feed Tube (large or small) and fill with primers as follows: Remove primers from box and place on loading bench – or RCBS Primer Tray – cup side up (anvil down). Holding Primer Feed Tube and Cotter Pin up, press other end of tube down onto primers – one at a time. When the Primer Feed Tube is full, insert the Cotter Pin end into the Automatic Primer Feed Body, as before. Remove the Cotter Pin and the Primers will drop down to the Stop Pin. The Automatic Primer Feed is now ready to use. **NOTE:** After priming is completed, replace the Cotter Pin. Primer Tube Capacity: 100 primers.

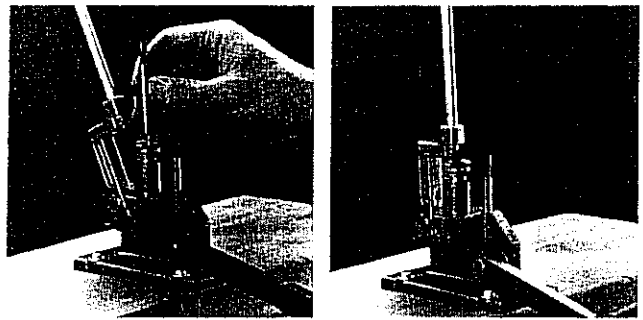

Insert the primer rod assembly.

Pushing the handle down will move the primer feed arm into position.

TO PRIME A CASE: Push handle (1) to the bottom of the stroke. The Primer Feed Arm (2) will automatically drop a primer into the Primer Rod Assembly (3). Next, quickly raise handle to the top of the stroke and insert a case into the Shell Holder (4). Then lower the handle gently and seat the primer to the bottom of the primer pocket. Raise the handle and remove the primed case.

Repeat the above procedure for each primer to be seated. With a little practice you'll develop a rhythm that will speed up your case priming operation.

AUTOMATIC PRIMING TOOL PARTS LIST

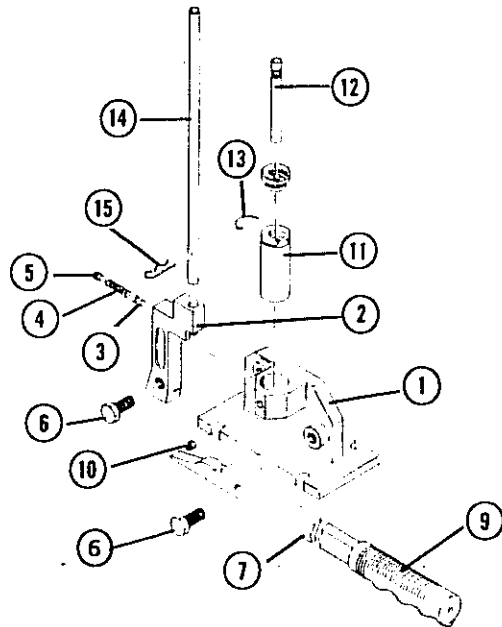

KEY	PART NO.	DESCRIPTION
1	09462	Main Body Casting
2	09472	Automatic Primer Feed Arm
3	09595	Stop Pin
4	09596	Coil Spring
5	09591	Setscrew, 1/16-28 x 1/16" CP
6	09464	Shoulder Bolt 1/8"
7	09473	Handle
9	09264	Handle Grip
10	09467	Setscrew, 1/16-18 x 1/16" HD
11	09468	Main Ram
12	09471	Primer Rod Assembly, Lg & Sm
13	09111	Spring Clip
14	09592	Primer Tube Assembly, Large
14	09593	Primer Tube Assembly, Small
15	09599	Primer Tube Cotter Pin
**	09465	Return Spring

**Not Shown

PRIMER POCKET SWAGER

NOTE: The Primer Pocket Swager is designed to remove the crimp and not to swage the entire primer pocket. If a primer will not seat properly after swaging the primer pocket, dispose of the case as the primer pocket is probably undersize.

The Primer Pocket Swager is designed for use in most "C" and "block-O" type presses with the standard $\frac{1}{8}$ "-14 thread and equipped with the removable type Shell Holder. The regular Swager Rod is used with the large or small Swager Head for all calibers except the .223 Remington. Use the .223 Remington (small) Swager Rod with the small Swager Head when swaging .223 Remington primer pockets.

If using the RCBS Big Max Press, you will need the optional Case Stripper for Big Max Press. It replaces the regular Case Stripper and is used only with the Big Max Press.

The optional Case Stripper Washer is required for use with the RCBS Model "A-2" Press. The Primer Pocket Swager is not adaptable for use with progressive reloading tools.

NOTE: If the Swager Rod is set too low, it will bend during the swaging operation. Read the following instructions carefully, proceed slowly and be sure you understand each step before going on to the next one.

TO INSTALL: Remove the Shell Holder in the reloading press and install the large or small Swager Head in the Shell Holder Ram. Then place the Case Stripper, cup side down, over the Swager Head. The swaging spud on the Swager Head will pass through the hole in the Case Stripper.

NOTE: If using the RCBS Model "A-2" Press, insert the Case Stripper Washer under the regular Case Stripper.

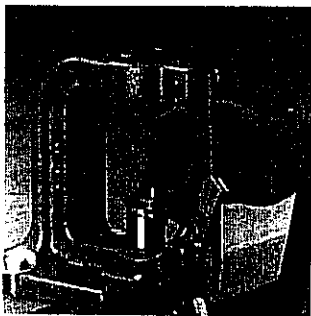

Install the swager head in the shell holder ram.

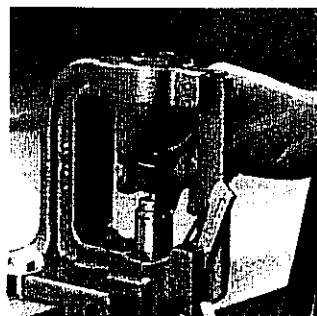

Place the case stripper over the swager head.

Lower the press handle until the Swager Head and Case Stripper are at the top of the press stroke.

The Swager Rod must be backed up snugly and securely tightened against the top of the Swager Body at all times to avoid damage to the Swager Rod. Be sure the small Lock Ring is tightened securely. The amount of swaging is controlled by moving the Swager Body up and down.

Screw the Swager Body into the press and allow about $\frac{1}{8}$ " between it and the Swager Head.

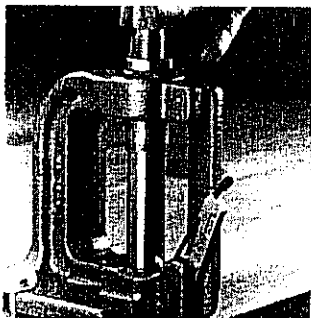

Lower the press handle and install the swager assembly.



With the handle raised, place a case on the swager head and lower the handle.

TO USE: First, sort cases by brand before swaging. Different brands of cases have different web thicknesses. Next, raise the press handle. Place the mouth of the case to be swaged over the Swager Rod and slowly lower the press handle. Lower the Swager Body until it contacts the web of the case (bottom of case interior). You will feel resistance. Slightly lift the press handle and lower the Swager Body about $\frac{1}{8}$ of a turn at a time until the proper depth is found. The swaged case will stick to the swaging spud on the Swager Head. To free it, lightly tap the handle backward when the handle is raised. When the primer pocket is properly swaged, tighten the Hex Lock Ring and you are ready to begin swaging. Inspect primer pockets to insure that the edge is radiused.

PRIMER POCKET SWAGER PARTS LIST

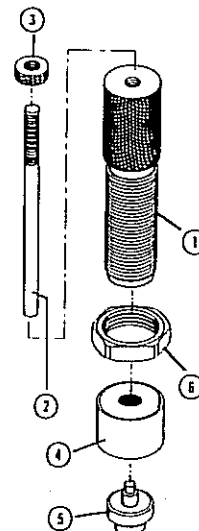

KEY	PART NO.	DESCRIPTION
1	09485	Swager Body
2	09486	Swager Rod
2	09498	Swager Rod .223 Remington
4	09487	Case Stripper
	09489	Case Stripper for Big Max Press
	09488	Case Stripper Washer for Model "A-2" Press
5	09483	Swager Head, Large
5	09484	Swager Head, Small
6	87505	Hex Lock Ring $\frac{1}{4}$ "-14
*Not Shown		

AUTOMATIC PRIMER FEED

WARNING: Care must be taken when loading the Auto Primer Feed Tube. DO NOT force primers. Because of the stacked condition of the primers, if one should ignite, all the primers in the tube can explode causing serious personal injury. No more than five pounds pressure should be applied when picking up primers with the Auto Primer Feed Tube (this can be checked using a bathroom scale). If difficulties occur in primer pick-up, investigate the cause and clear the condition or return the Auto Primer Feed Tube to RCBS for correction.

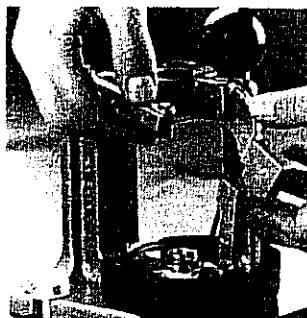

Installing the APF Body in the milled slot of a Rock Chucker Press.

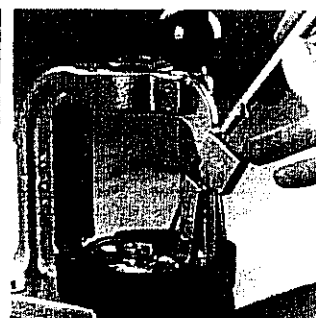

Insert the primer tube into the APF Body.

The RCBS Automatic Primer Feed is designed for the RCBS Reloader Special, Jr. and Rock Chucker Presses and most "C" type presses. The large and small Automatic Primer Feed tubes interchangeably fit the Automatic Primer Feed Body.

TO INSTALL: Insert the Cotter Pin end of an empty Tube into the Primer Feed Body. Then slide the Holding Bracket of the Body into the milled slot in the frame of the reloading press. Tighten Allen-type setscrew(s) in press frame. Now adjust the Body until the Primer Feed Tube lines up with the Primer Plug and is about 1/2" above the Primer Sleeve. Primer Tube Capacity: 100 primers.

TO FILL TUBE: Select the proper Automatic Primer Feed Tube (large or small) and fill with primers as follows: Remove primers from box and place on loading bench – or RCBS Primer Tray – cup side up (anvil down). Holding Primer Feed Tube with Cotter Pin up, press other end of Tube down onto Primers – one at a time. **SEE WARNING ABOVE BEFORE CONTINUING.** When the Primer Feed Tube is full, insert the Cotter Pin end into the Automatic Primer Feed Body, as before. Remove the Cotter Pin and the Primers will drop down to the Stop Pin.

The Automatic Primer Feed is now ready to use. **NOTE:** After priming is completed, replace the Cotter Pin.

TO USE: Gently pull the Primer Arm back to activate the Primer Stop Pin. A primer will drop into the Primer Plug and Sleeve.

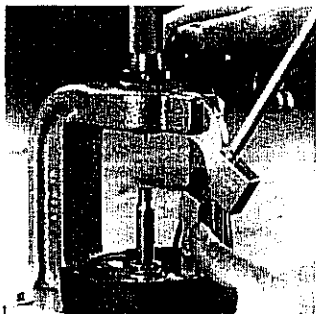

Gently pull the primer arm back to pick up a primer.

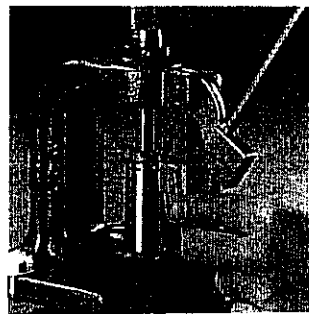

Push the primer arm forward and lower the press handle.

AUTOMATIC PRIMER FEED PARTS LIST

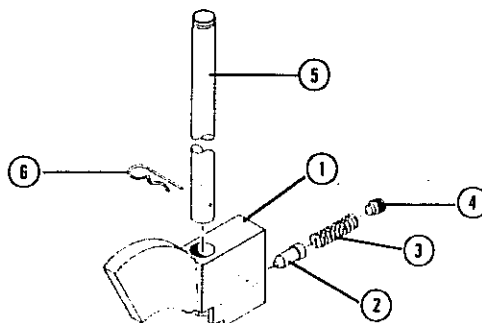

KEY	PART NO.	DESCRIPTION
1	09594	Body Assembly
1	09598	Body
2	09595	Stop Pin
3	09596	Coil Spring
4	09591	Setscrew, 1/4-28 x 1/4" CP
5	09592	Primer Tube Assembly, Large
5	09593	Primer Tube Assembly, Small
6	09599	Primer Tube Cotter Pin

PRIMER POCKET BRUSH

A couple of twists and this tool thoroughly cleans residue out of primer pockets. The brushes, with stainless bristles, have interchangeable mounts for large and small primer pockets, and fit easily into the no-roll Accessory Handle.

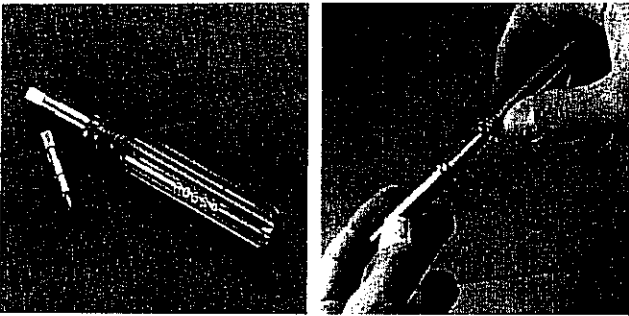

Primer Pocket Brush Combo

A quick twist and the primer pocket is cleaned.

PRIMER POCKET BRUSH PARTS LIST

PART NO.	DESCRIPTION
09574	Primer Pocket Brush Combo
09577	Primer Pocket Brush only, Large
09578	Primer Pocket Brush only, Small
09330	Accessory Handle

PRIMER TRAY

This Primer Tray is designed to position primers anvil side up, for fast, easy handling. To use: scatter primers onto the specially grooved surface of the Primer Tray. Shake tray horizontally until all primers are positioned anvil side up. Primers can now be picked up manually and inserted directly into the Primer Arm Sleeve. For Automatic Primer Feed Tube loading, simply replace cover on Primer Tray. Then, turn the tray upside down. All primers will now be positioned anvil side down, and can be easily picked up with the top end of your Automatic Primer Feed Tube. Sturdy plastic case permits safe, easy storage of primers. Tray capacity: 100 primers.

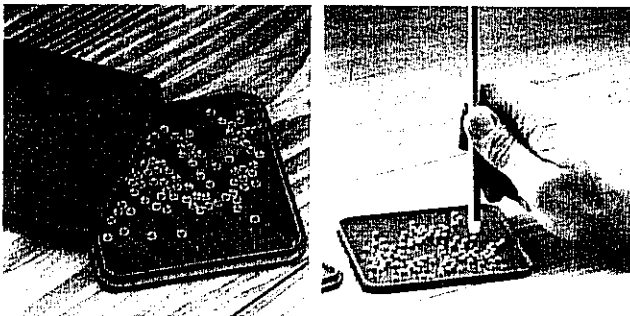

Primer Tray

Filling a primer tube is easy with the RCBS Primer Tray.

BERDAN DECAPPING TOOL

This essential tool offers reloaders of Berdan cases the only practical dry method for the easy removal of Berdan primers. Decaps a wide range of Berdan cases, such as 8mm Rimless, 6.5mm Mannlicher-Schoenauer, and 11.7mm Rimmed. All functional parts are made from top grade alloyed steels, and heat-treated for lasting performance and efficiency. The Decapping Pin is made from high grade tool steel. Comes complete with case holder and Allen wrench.

Do not remove "live" primers. To do so could cause primer ignition, causing serious personal injury. Always examine primers to make certain they have been fired before attempting to remove them.

TO USE:

- Grasp Case Holder Rod [A] in left hand and place the fired case over it as shown.
- With your right hand grasp Decapper, and hook Decapper jaw [B] under the rim, or extractor groove, of the case.
- Now place the point of Decapping Pin [C] into the firing pin dent in the primer. Press the handle gently but firmly down, and the primer will be ejected. Should the primer fail to eject easily adjust the Decapping Pin upward or downward with the Allen Setscrew [D].

NOTE: If Decapping Pin is too long, it will damage the anvil in the case.

IMPORTANT: Do not use this tool to remove crimped-in primers found in most military cases.

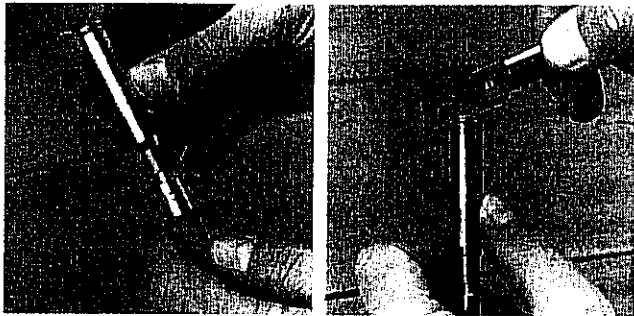

Place a fired case over the case holder rod.

Gently push the decapping pin into the fired primer to remove it from the case.

BERDAN DECAPPING TOOL PARTS LIST

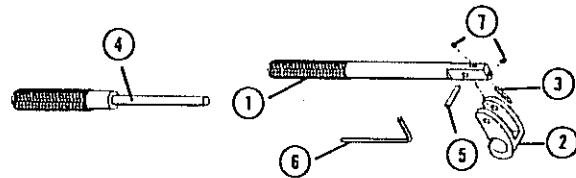

KEY	PART NO.	DESCRIPTION
1	09526	Handle
2	09527	Head
3	09528	Decapping Pin
4	09532	Case Holder Assembly
5	09533	Head Cross Pin
6	09534	Allen Wrench $\frac{1}{16}$ "
7	09509	Setscrew, $\frac{1}{16}$ x $\frac{1}{8}$ " (2)

PLASTIC AMMO BOXES FROM RCBS

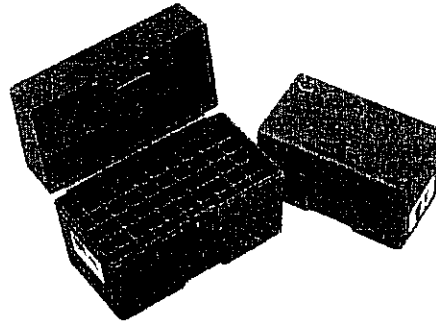

How can anyone improve on something as basic as a plastic box? We figured out about eight ways and included them in five different sized ammo boxes. RCBS plastic ammo boxes offer unique features that make all others obsolete, including a one-piece hinge, recessed latch, label for identifying contents, interlocking tabs, flush exterior and more. Great for securely packing, storing, carrying and dispensing most popular rifle or pistol cartridges. See the chart below for part numbers and descriptions of the five different sizes.

PART NO.	DESCRIPTION
86901	AmmoBox, Small Rifle
86902	AmmoBox, Medium Rifle
86903	AmmoBox, Large Rifle
86905	AmmoBox, Medium Pistol
86906	AmmoBox, Large Pistol

See your local dealer or contact RCBS for further information.

RCBS[®]

PRECISIONEERED[®] RELOADING EQUIPMENT

*We think that we make the very best
reloading equipment in the world.
If you agree, please tell your friends.
If you disagree, tell us - we want to do something about it!*

Customer Service

1-800-533-5000 (US or Canada) or 530-533-5191

Hours: Monday - Thursday, 6:30am - 3:00pm (hours may vary)

e-mail: rcbs.tech@atk.com • www.rcbs.com

RCBS • 605 Oro Dam Blvd. • Oroville, CA 95965

CCI • SPEER • RCBS
OUTERS • RAMLINE • ORBEX • FEDERAL

200500/0605